

INDUNORM PRODUKTE



GESAMTÜBERSICHT

GRÖSSTER THK-PARTNER

IN EUROPA

THK-LINEARFÜHRUNGEN



THK
The Mark of Linear Motion

KUGELGEWINDETRIEBE



 **kammerer**[®]
Kompetenz in Gewindetechnik

THK
The Mark of Linear Motion

SONDERBEARBEITUNG FÜHRUNGEN



SONDERBEARBEITUNG SPINDELN

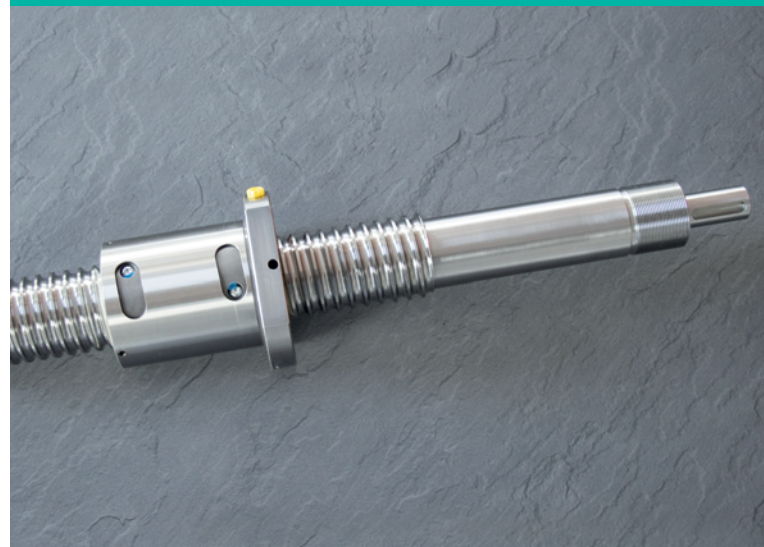

KUNDENSPEZIFISCHE ANPASSUNG



KORROSIONSSCHUTZ

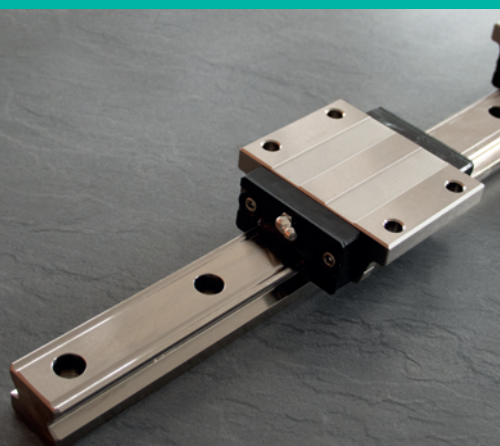

VORSPANNUNGSANPASSUNG



KUNDENSPEZIFISCHE BEARBEITUNG IST UNSER STANDARD

KUGELKEIL- UND KUGELNUTWELLEN



THK
The Mark of Linear Motion

TELESKOPSCIENEN

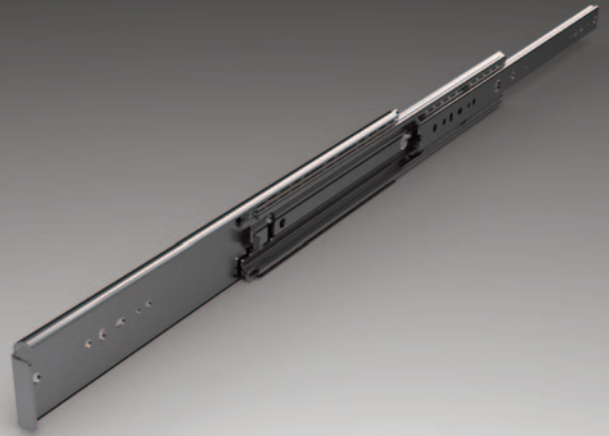

KUGELBUCHSEN UND WELLEN



THK
The Mark of Linear Motion

SAMICK

KUGELKÄFIGSYNCHRONISIERTE TELESKOPSCIENEN

Neu
&
innovativ



GROSSES LAGER



EINZELBEARBEITUNG



GROSSE STÜCKZAHLEN



KREUZROLLENLAGER

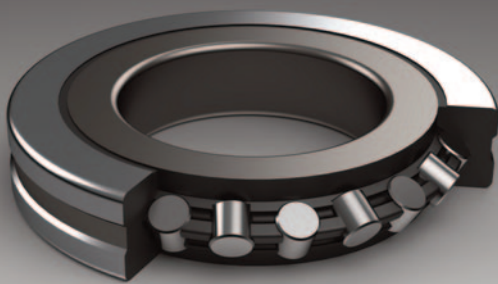

THK
The Mark of Linear Motion

LAUFROLLENFÜHRUNGEN

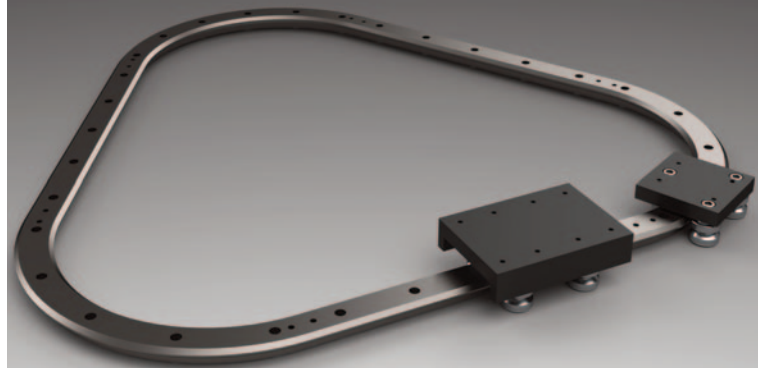

ZAHNRIEMEN- / SPINDELACHSEN

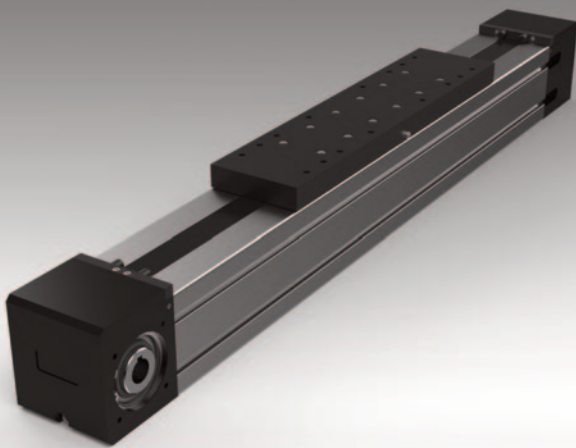

ACHSSYSTEME



3-ACHS-SYSTEM

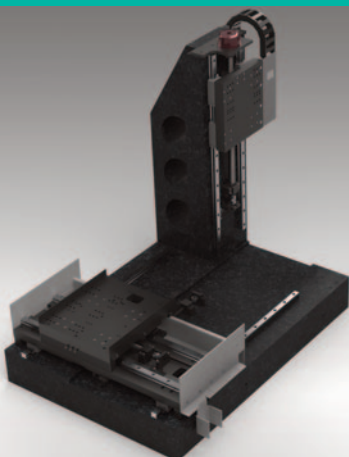

KREUZTISCH

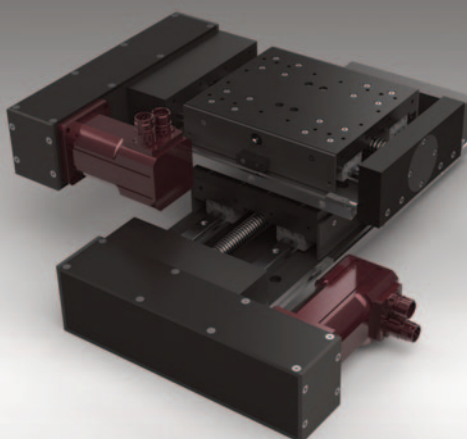

KOMPLETTANLAGEN



STARKE ENTWICKLUNGEN

MADE IN GERMANY

INDUMATIK® – WERKSTÜCKWECHSLER

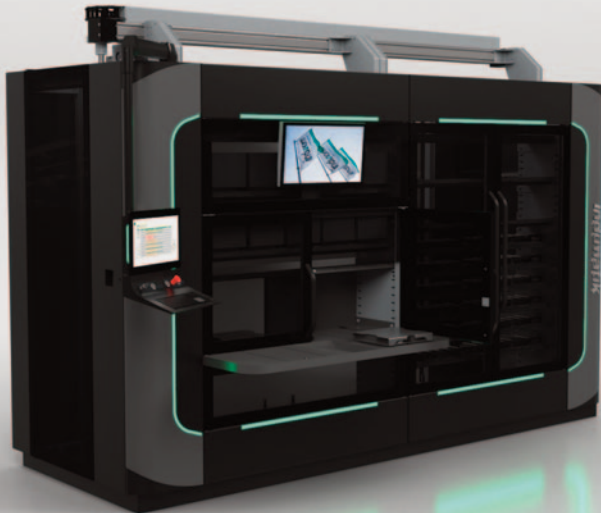

INDUMATIK® – WERKZEUGWECHSLER



BODENFAHRWERK BFW – für Linearachsroboter und 7. Achse für Knickarmroboter

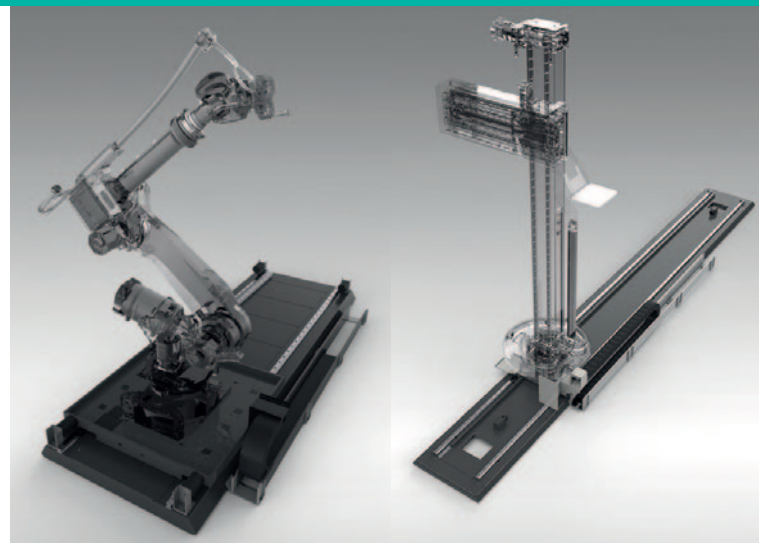
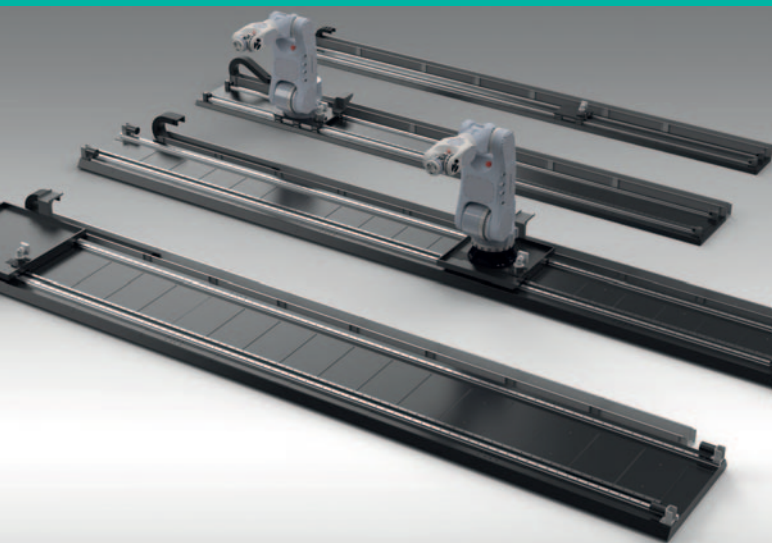

INDUENERGY – ENERGIESPAREN IN DER FERTIGUNG

induenergy
by Indunorm



INDUNORM

GESAMTPROGRAMM

- / THK-Linearführungen
- / Kugelgewindetriebe
- / Laufrollenführungen
- / Teleskopführungen
- / CNC-Bearbeitung
- / Linearachsen
- / Kugelbuchsen
- / Indumatik®
- / InduEnergy

Zentrale
Standort Duisburg
Indunorm
Bewegungstechnik GmbH
Obere Kaiserswerther Str. 17
D-47249 Duisburg
Telefon +49 203 76 91-0
E-Mail: bt@indunorm.eu

Standort Keniastraße
Indunorm
Bewegungstechnik GmbH
Keniastraße 12
D-47269 Duisburg
Telefon +49 203 76 91-110
E-Mail: indumatik@indunorm.eu

Standort Stuttgart
Indunorm
Bewegungstechnik GmbH
Eisentalstraße 31
D-71332 Waiblingen
Telefon +49 7151 97502-10
E-Mail: sued@indunorm.eu



www.indunorm.eu

indunorm
Bewegungstechnik